

PT8CN

CANbus • SAE J1939 Output Signal

Industrial Grade String Pot

Absolute Linear Position to 60 inches (1524 mm)

Aluminum or Stainless Steel Enclosure Options

NEMA 6 / IP67

GENERAL

Full Stroke Ranges	0-2 to 0-60 inches
Electrical Interface	CANbus SAE J1939
Protocol	Proprietary B
Accuracy	see ordering information
Repeatability	± 0.02% full stroke
Resolution	± 0.003% full stroke
Measuring Cable Options	stainless steel or thermoplastic
Enclosure Material	powder-painted aluminum or stainless steel
Sensor	plastic-hybrid precision potentiometer
Potentiometer Cycle Life	see ordering information
Maximum Retraction Acceleration	see ordering information
Weight, Aluminum (Stainless Steel) Enclosure	3 lbs. (6 lbs.), max.

ELECTRICAL

Input Voltage	7 - 18 VDC
Input Current	60 mA max.
Baud Rate	125K, 250K, or 500K via DIP switches
Update Rate	10 ms. (20 ms. available, contact factory)

ENVIRONMENTAL

Environmental Suitability	NEMA 4X/6, IP 67
Operating Temperature	-40° to 185°F (-40° to 85°C)
Vibration	up to 10 g to 2000 Hz maximum

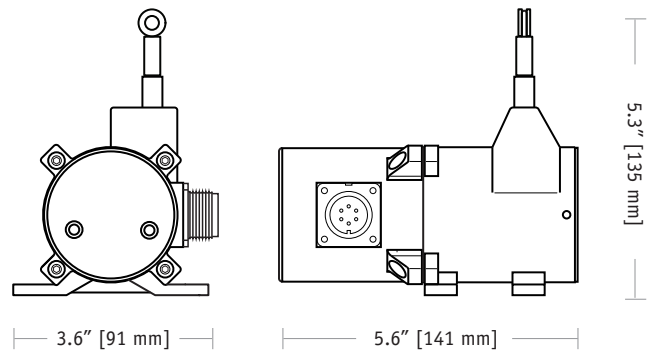

The PT8CN, using a high cycle plastic-hybrid potentiometer, communicates to your PLC via the CANbus SAE J1939 interface. Suitable for factory and harsh environment applications requiring linear position feedback in ranges up to 60".

As a member of Celesco's innovative family of NEMA 4 rated cable-extension transducers, the PT8CN installs in minutes by simply mounting its body to a fixed surface and attaching its cable to the movable object. Perfect parallel alignment not required.

Output Signal:

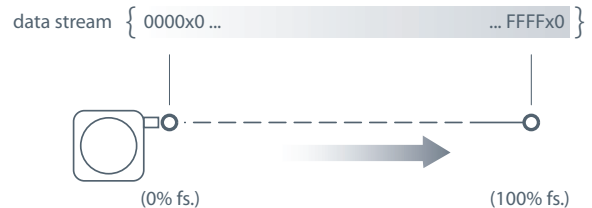

I/O Format and Settings

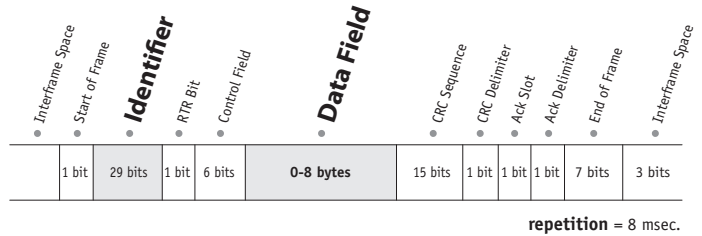

Identifier

	Message Priority					Future Use					J1939 Reference Proprietary B								Data Field Type*				Not Used		Node ID**										
Example	1	0	0	0	0	1	1	1	1	1	1	1	1	1	1	1	1	1	0	1	0	1	0	0	1	1	0	0	1	1	1	1	1	1	1
Identifier Bit No.	28	27	26	25	24	23	22	21	20	19	18	17	16	15	14	13	12	11	10	9	8	7	6	5	4	3	2	1	0						
Hex Value	0					F					F					5				3				3		F									

*Sensor field data can be factory set to customer specific value. **Customer defined, set via Dips 1-6. Bit values shown for example only, see **Address Setting** below.

Data Field

- B₀ = LSB current % of measurement range byte
- B₁ = MSB current % of measurement range byte
- B₂ = LSB current measurement count byte
- B₃ = MSB current measurement count byte

- B₄ = error flag
- B₅ = error flag
- B₆ = LSB velocity data byte
- B₇ = MSB velocity data byte

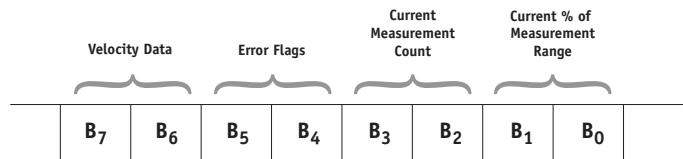

B ₇	B ₆	B ₅	B ₄	B ₃	B ₂	B ₁	B ₀
----------------	----------------	----------------	----------------	----------------	----------------	----------------	----------------

Current Measurement Count

The **Current Measurement Count (CMC)** is the output data that indicates the present position of the measuring cable. The CMC is a 16-bit value that occupies bytes **B₂** and **B₃** of the data field. **B₂** is the **LSB** (least significant byte) and **B₃** is the **MSB** (most significant byte).

The **CMC** starts at **0x0000** with the measuring cable fully retracted and continues upward to the end of the stroke range stopping at **0xFFFF**. This holds true for all ranges.

Converting CMC to Linear Measurement

To convert the current measurement count to inches or millimeters, simply divide the count by 65,535 (total counts over the range) and then multiply that value by the full stroke range:

$$\left(\frac{\text{current measurement count}}{65,535} \right) \times \text{full stroke range}$$

Sample Conversion:

If the full stroke range is **30 inches** and the current position is **0x0FF2** (4082 Decimal) then,

$$\left(\frac{4082}{65,535} \right) \times 30.00 \text{ inches} = 1.87 \text{ inches}$$

If the full stroke range is **625 mm** and the current position is **0x0FF2** (4082 Decimal) then,

$$\left(\frac{4082}{65,535} \right) \times 625 \text{ mm} = 39 \text{ mm}$$

B ₇	B ₆	B ₅	B ₄	B ₃	B ₂	B ₁	B ₀
----------------	----------------	----------------	----------------	----------------	----------------	----------------	----------------

Current % of Measurement Range

The **Current % of Measurement Range** is a 2-byte value that expresses the current linear position as a percentage of the entire full stroke range. Resolution is **.1 %** of the full stroke measurement range.

This value starts at **0x0000** at the beginning of the stroke and ends at **0x03E8**.

Example:

Hex	Decimal	Percent
0000	0000	0.0%
0001	0001	0.1%
0002	0002	0.2%
...
03E8	1000	100.0%

B ₇	B ₆	B ₅	B ₄	B ₃	B ₂	B ₁	B ₀
----------------	----------------	----------------	----------------	----------------	----------------	----------------	----------------

Error Flags

0x55 (yellow LED on controller board) indicates that the sensor has begun to travel beyond the calibrated range of the internal position potentiometer.

0xAA (red LED on controller board) indicates that the sensor has moved well beyond the calibrated range of the internal position potentiometer.

If either error flag occurs within the full stroke range of the sensor, the unit should be returned to the factory for repair and recalibration.

B ₇	B ₆	B ₅	B ₄	B ₃	B ₂	B ₁	B ₀
----------------	----------------	----------------	----------------	----------------	----------------	----------------	----------------

Velocity

Data in bytes **B₇** - **B₆** is the change in the **CMC** (current measurement count) over a 100 msec time period. This data can then be used to calculate velocity in a post processing operation.

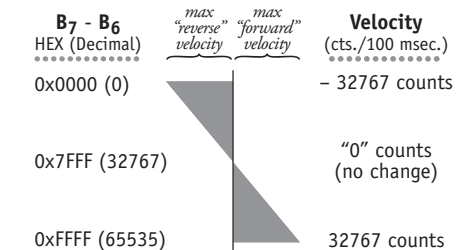

Velocity Calculation

$$\left(\frac{\text{count change} - 32767}{.1 \text{ sec. time period}} \right) \times \left(\frac{\text{full stroke range}}{65,535} \right)$$

Sample Calculations

Cable Extension (positive direction):

$$\text{B}_7\text{-B}_6 = \text{0x89C6} \text{ (43462 Dec), full stroke} = 60 \text{ in.}$$

$$\left(\frac{35270 - 32767}{.1 \text{ sec}} \right) \times \left(\frac{60 \text{ in.}}{65,535} \right) = 22.92 \text{ in. / sec.}$$

Cable Retraction (negative direction):

$$\text{B}_7\text{-B}_6 = \text{0x61A8} \text{ (25000 Dec), full stroke} = 60 \text{ in.}$$

$$\left(\frac{25000 - 32767}{.1 \text{ sec}} \right) \times \left(\frac{60 \text{ in.}}{65,535} \right) = -71.11 \text{ in. / sec.}$$

Setting the Address (Node ID) and Baud Rate

Address Setting (Node ID)

The Address Setting (Node ID) is set via 6 switches located on the 8-pole DIP switch found on the DeviceNET controller board located inside the transducer.

The DIP switch settings are binary starting with switch number 1 (= 2⁰) and ending with switch number 6 (= 2⁵).

DIP-1 (2 ⁰)	DIP-2 (2 ¹)	DIP-3 (2 ²)	DIP-4 (2 ³)	DIP-5 (2 ⁴)	DIP-6 (2 ⁵)	address (decimal)
0	0	0	0	0	0	0
1	0	0	0	0	0	1
0	1	0	0	0	0	2
...
1	1	1	1	1	1	63

Baud Rate

The transmission baud rate may be either factory preset at the time of order or set manually at the time of installation.

The baud rate can be set using switches 7 & 8 on the 8-pole DIP switch found on the DeviceNET controller board located inside the transducer.

DIP-7	DIP-8	baud rate
0	0	125k
1	0	250k
0	1	500k
1	1	125k



CANBus Controller Board

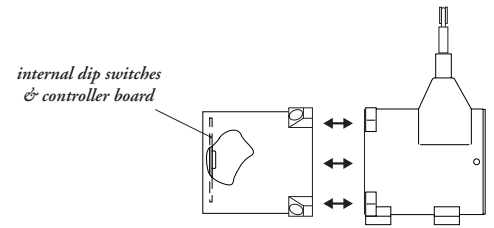
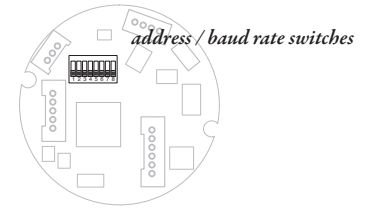

to gain access to the controller board, remove four Allen-Head Screws and remove rear cover.

Outline Drawing:

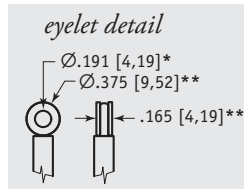
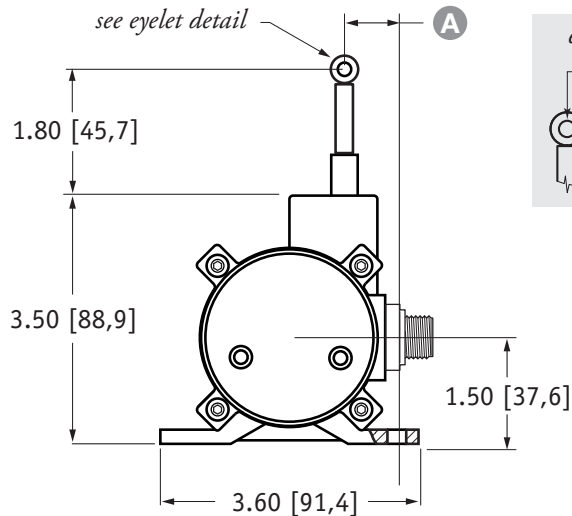

RANGE	A
2", 10"	1.16 [29,5]
5", 25", 50"	0.66 [16,8]
15"	0.99 [25,7]
20", 40"	0.85 [21,6]
30", 60"	0.52 [13,3]

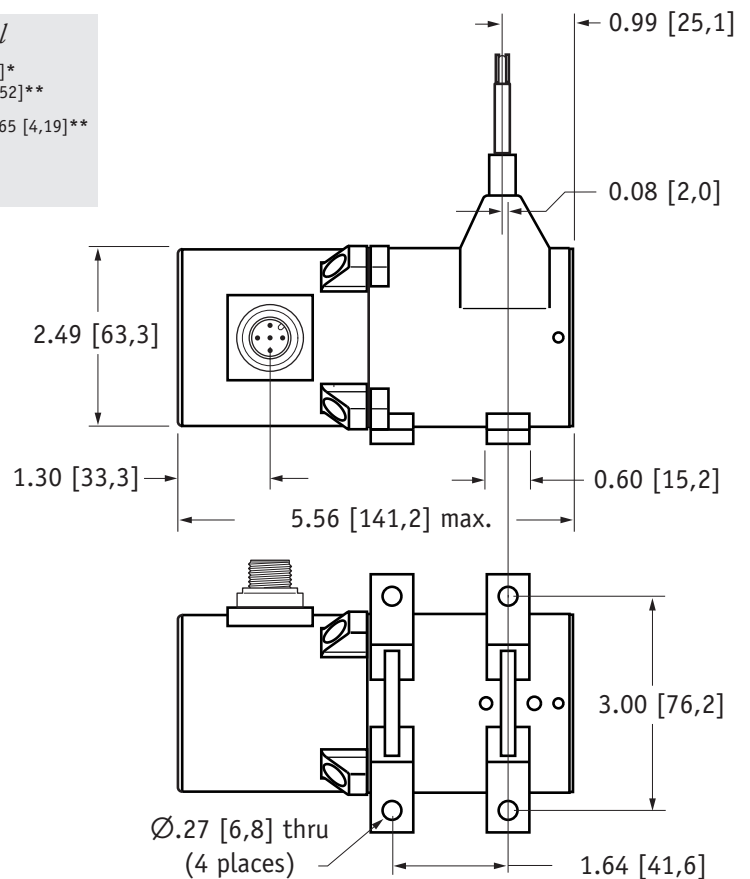

DIMENSIONS ARE IN INCHES [MM]

tolerances are ± 0.02 in. [$\pm 0,5$ mm] unless otherwise noted

note: *tolerance = $+0.005 -0.001$ [$+0.13 -0.03$] **tolerance = $+0.005 -0.005$ [$+0.13 -0.13$]

Ordering Information:

Model Number:

PT8CN - - - - - - - - -

order code: **R** **A** **B** **C** **D** **J** **E** **F** **G** **H**

Sample Model Number:

PT8CN - 50 - AL - N34 - T1 - CG - J - 500 - 32 - SC5

- R** range: 50 inches
- A** enclosure: aluminum
- B** measuring cable: .034 nylon-coated stainless
- C** measuring cable tension: standard
- D** cable guide: standard
- J** interface: CANbus SAE J1939
- E** baud rate: 500 k bits/sec.
- F** node ID: 32 decimal
- H** electrical connection: 5-meter cordset with straight plug

Full Stroke Range:

R order code:	2	5	10	15	20	25	30	40	50	60
full stroke range, min:	2 in.	5 in.	10 in.	15 in.	20 in.	25 in.	30 in.	40 in.	50	60
accuracy (% of f.s.):	0.25%	0.25%	0.15%	0.15%	0.15%	0.15%	0.15%	0.10%	0.10%	0.10%
potentiometer cycle life*:	2.5 x 10 ⁶	2.5 x 10 ⁶	5 x 10 ⁵	5 x 10 ⁵	5 x 10 ⁵	5 x 10 ⁵	5 x 10 ⁵	2.5 x 10 ⁵	2.5 x 10 ⁵	2.5 x 10 ⁵

*-1 cycle is defined as the travel of the measuring cable from full retraction to full extension and back to full retraction

Enclosure Material:

A order code:	AL	SS	316
	powder-painted aluminum	303 stainless steel	316 stainless steel

Measuring Cable:

B order code:	N34	S47	V62
	Ø.034-inch nylon-coated stainless steel <i>available in all ranges</i>	Ø.047-inch stainless steel <i>5, 15, 20, 25, 30-inch ranges only</i>	Ø.062-inch thermoplastic <i>all ranges up to 30 inches only</i>

Measuring Cable Tension:

C order code:		T1	T2	T3
		standard tension	medium tension	high tension
full stroke range cable tension specifications	2, 10-inch:	39 oz.	65 oz.	116 oz.
	15-inch:	26 oz.	43 oz.	77 oz.
	20, 40-inch:	20 oz.	33 oz.	60 oz.
	5, 25, 50-inch:	16 oz.	26 oz.	47 oz.
	30, 60-inch:	13 oz.	22 oz.	40 oz.
		tension tolerance: ± 50%		
		<i>maximum acceleration</i>	<i>maximum acceleration</i>	<i>maximum acceleration</i>
aluminum enclosure:	15 g	25 g	40 g	
stainless steel enclosure:	6 g	12 g	18 g	

Cable Guide:

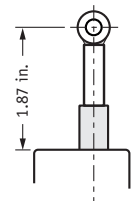
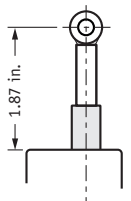
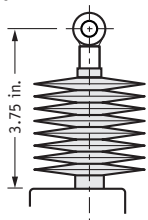
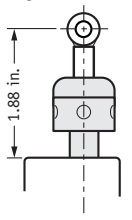
D order code:	CG	SS	CB*	BR
	standard cable guide	stainless steel cable guide	polyurethane cable guide	integral cable brush
				

*note: all ranges up to 25 inches only

Ordering Information (cont.):

Baud Rate:

order code:	125	250	500
	125 kbaud	250 kbaud	500 kbaud

Node ID:

order code:	0	1	2	...	62	63
	select address (0 - 63 Decimal)					

Electrical Connection:

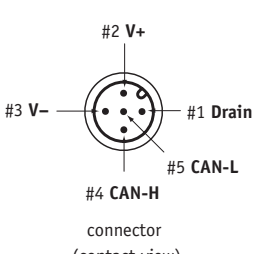
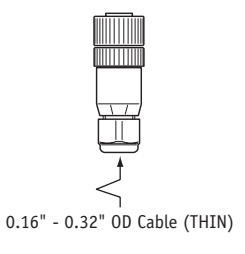
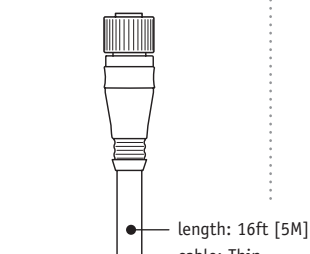
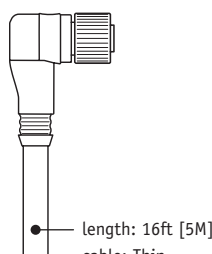
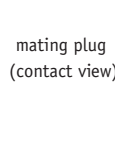
order code:	blank	MC5	SC5	NC5																		
	5-pin micro-connector <i>(no mating plug supplied)</i>	5-pin micro-connector w/ mating plug	5-pin micro-connector and 5 meter length cordset w/straight mating plug	5-pin micro-connector and 5 meter length cordset w/90° mating plug																		
	 <p>connector (contact view)</p>	 <p>0.16" - 0.32" OD Cable (THIN)</p>	 <p>length: 16ft [5M] cable: Thin</p>	 <p>length: 16ft [5M] cable: Thin</p>																		
		 <p>mating plug (contact view)</p>	<table border="1"> <thead> <tr> <th>pin</th> <th>signal</th> <th>wire color</th> </tr> </thead> <tbody> <tr> <td>1</td> <td>drain</td> <td>brown</td> </tr> <tr> <td>2</td> <td>V+</td> <td>white</td> </tr> <tr> <td>3</td> <td>V-</td> <td>blue</td> </tr> <tr> <td>4</td> <td>Can-H</td> <td>black</td> </tr> <tr> <td>5</td> <td>Can-L</td> <td>grey</td> </tr> </tbody> </table>	pin	signal	wire color	1	drain	brown	2	V+	white	3	V-	blue	4	Can-H	black	5	Can-L	grey	
pin	signal	wire color																				
1	drain	brown																				
2	V+	white																				
3	V-	blue																				
4	Can-H	black																				
5	Can-L	grey																				

version: 9.0 last updated: October 2, 2012

Cable Guide Options:

ⓐ *order code:*

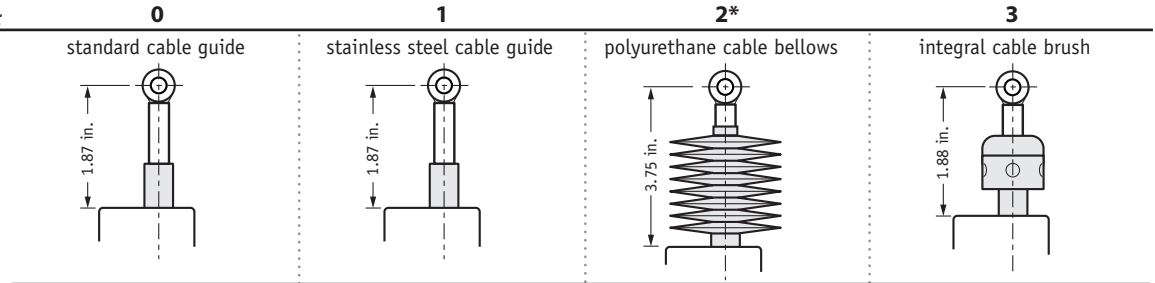

*note: all ranges up to 25 inches only

Output Signal Selection:

The output signal direction can be reversed at any time by simply changing the dip-switch settings found on the internal signal board. After the settings have been changed, adjustment of the Zero and Span trimpots will be required to precisely match signal values to the beginning and end points of the stroke.

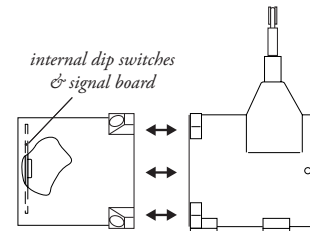
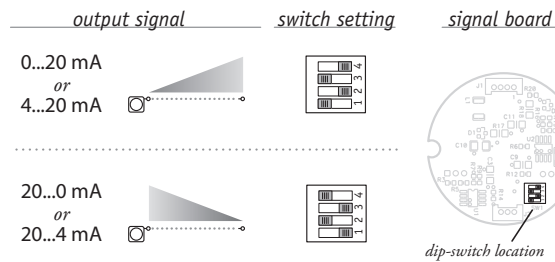

To gain access to the signal board, remove four Allen-Head Screws and remove rear cover.

北京赛斯维测控技术有限公司
 北京市朝阳区望京西路48号
 金隅国际C座1002
 电话：+86 010 8477 5646
 传真：+86 010 5894 9029
 邮箱：sales@sensorway.cn
<http://www.sensorway.cn>

draft: 2.0 last updated: April 12, 2011

